



Mercedes-Benz

## Accessories

### Installation Instructions

Mobile telephone cradle

Nokia 6700

© 2009, Daimler AG

10/09  
03F059-09

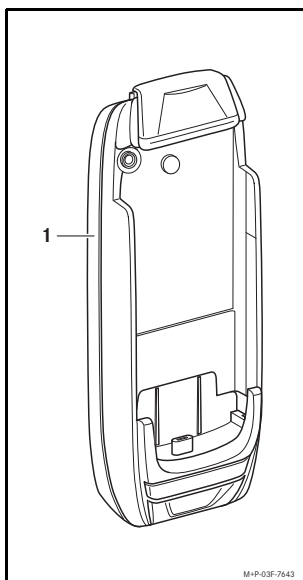

M-P-03F-7643



#### Validity

These installation instructions are valid for vehicles equipped with a

- Mobile phone fitting with universal interface or Convenience Telephony (Code 386) or
- Mobile phone fitting with universal interface (Code 388)

Each in combination with Nokia mobile phones 6700.

#### Components

- (1) Mobile phone cradle

In the following text, this will be referred to as "cradle".

#### Notes

Please contact a qualified specialist workshop if you encounter difficulties when fitting the telephone module. Mercedes-Benz recommends that you use a Mercedes-Benz Service Centre for this purpose.

The manufacturer reserves the right to change technical details from those shown in the illustrations contained in these installation instructions.

These installation instructions also refer to the COMAND and Audio Operating Instructions, the vehicle Owner's Manual and the mobile phone operating instructions. Please keep them handy for reference.

At high outside temperatures, the cradle can become very hot when in operation, as is the case with the vehicle interior itself.

Do not open up the cradle and do not make any modifications on the cradle. Otherwise the type approval will be rendered invalid.

1

2

#### Contents

Fitting the holder	▷ 4
Inserting the mobile phone	▷ 5
Pairing the mobile phone with the cradle	▷ 6
Connecting the mobile phone to the cradle	▷ 8
• Connecting the mobile phone manually	▷ 9
• Connecting the mobile phone automatically	▷ 10
Automatically disconnecting the Bluetooth® connection between the mobile phone and the cradle	▷ 11
Manually disconnecting the Bluetooth® connection between the mobile phone and the cradle	▷ 11
General notes on operation	▷ 12
Speed-dial keys	▷ 13
Transferring the phone book	▷ 14
Removing the mobile phone	▷ 15
Removing the cradle	▷ 15

3



#### Risk of accident

Please comply with the legal regulations of the country in which you are driving when you are using the telephone inside the vehicle.

If it is legally permissible to use the telephone while driving, only do so when traffic conditions allow for it. You may otherwise become distracted from the traffic, which may lead to an accident in which you or others may be injured.

For safety reasons, only use the hands-free system when making calls while driving.

When you are using the mobile phone via the hands-free system, drive with extra caution, close all windows and try to eliminate background noise.

Please pull over or park the car if you do not wish to use the hands-free system to make a call. Do not stop the vehicle or park where it is prohibited to do so.

Place the telephone module into the cradle only while the vehicle is at a standstill. You could otherwise be distracted and cause an accident.

4

#### Fitting the holder

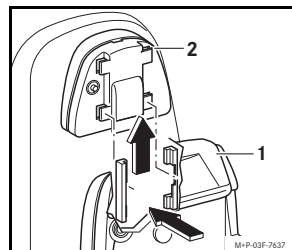

Slide the cradle (1) onto the contact plate (2) until it audibly engages.

## 5 Inserting the mobile phone

It is only possible to use the hands-free system and the telephone functions via the operating system/on-board computer if there is a Bluetooth® connection between the mobile phone and the cradle.

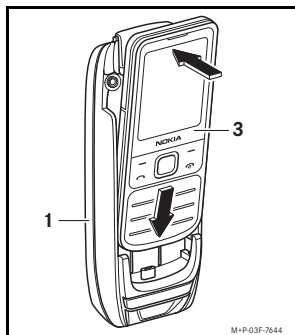

Insert the mobile phone (3) in the cradle (1) as shown.

## 6 Pairing the mobile phone with the cradle

For pairing, the mobile phone must not be in the cradle, but it must be in the vehicle.

### Note (valid for C-class vehicles, model series W/S 204)

The mobile phone should always be inserted in the cradle for pairing.

1. Turn the key to position 1, 2 or 3 in the ignition lock. (Please refer to the vehicle Owner's Manual.)

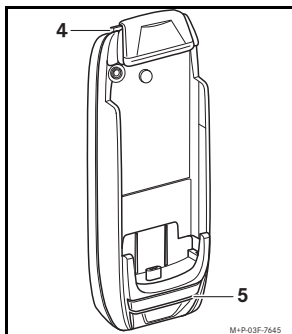

2. Press the Bluetooth® button (4) for approximately 2 seconds. The LED (5) flashes rapidly. The mobile phone cradle switches to Discovery Mode and can be recognised by the mobile phone.

3. Select *Menu* → *Settings* → *Connectivity* → *Bluetooth* → *On* on the mobile phone. (Please refer to the mobile phone operating instructions.)

4. Select *Menu* → *Settings* → *Connectivity* → *Bluetooth* → *Paired devices* → *Add new device* on the mobile phone. (Please refer to the mobile phone operating instructions.) The mobile phone begins searching for the cradle. When the mobile phone finds the cradle, *MB N6700Cradle* appears on the mobile phone.

5. Select *MB N6700Cradle* on the mobile phone.

After confirmation, a passkey request appears on the display.

6. Enter passkey 62872 on the mobile phone.

7. Confirm *Connect? With MB N6700Cradle* on the mobile phone with *Accept*.

8. *Added to paired devices list.*

Confirm *Connect?* and *Allow this device to connect automatically?* on the mobile phone with *Yes* in order to make an automatic connection between the mobile phone and the cradle possible.

9. The mobile phone is ready to be used with the hands-free system as soon as *Connected to MB N6700Cradle* appears on the mobile phone.

### Note

A maximum of 4 mobile phones may be paired with the cradle. If a fifth mobile phone is paired with the mobile phone cradle, the mobile phone that was paired first is deleted.

## 8

### Connecting the mobile phone to the cradle

After the pairing, the connection between the mobile phone and the cradle is established automatically. The LED on the cradle lights up continuously.

In order for the hands-free system to function properly, the phone may not be connected with the Bluetooth® interface of COMAND or the Audio System. Please refer to the separate Operating Instructions of COMAND or the Audio System.

Insert the mobile phone in the cradle and turn the ignition key to position 1, 2 or 3. (Please refer to the vehicle Owner's Manual.)

### Notes

If the mobile phone cradle and the mobile phone are not connected automatically, the connection can be established manually (▷ 9).

The mobile phone battery is charged when the ignition key is in position 1, 2 or 3, provided that the mobile phone is inserted in the cradle.

Not every ring tone can be issued by COMAND or the vehicle's operating system/on-board computer.

While there is a connection between the mobile phone and the cradle, the name of the mobile service provider is displayed in the operating system/on-board computer, as long as there is sufficient reception.

## 9

### Manually connecting the mobile phone with the cradle

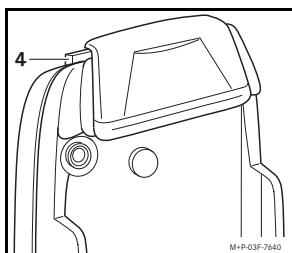

1. Push the Bluetooth® button (4) on the cradle.

2. Select *Menu* → *Settings* → *Connectivity* → *Bluetooth* → *Paired devices* → *MB N6700Cradle* → *Connect* on the mobile phone. (Please refer to the mobile phone operating instructions.)

Or:

For the following vehicles: S-Class, model series W/V 221 and CL-Class, model series C 216:

- Select *Tel* → *Tel* → *Telephone* using the COMAND controller. (Please refer to the vehicle Owner's Manual.)

On some model series

- Press the **TEL** button. (Refer to the COMAND or Audio Operating Instructions.)

### Note

Before being manually connected, the mobile phone must be paired with the cradle (▷ 6).

## 10

### Automatically connecting the mobile phone with the cradle

1. Select *Menu* → *Settings* → *Connectivity* → *Bluetooth* → *Paired devices* on the mobile phone. (Please refer to the mobile phone operating instructions.)

2. Select *MB N6700Cradle* on the mobile phone.

3. Select *Options* → *Settings* → *Autoconn., no conf.* on the mobile phone and confirm with *Yes*. (Please refer to the mobile phone operating instructions.)

### Note

Within a range of several meters to the cradle, the Bluetooth® connection remains active and any incoming calls are taken on the hands-free system. Therefore, the connection between the mobile phone and the cradle should be disconnected manually when you leave the vehicle (▷ 11).

### Automatically disconnecting the Bluetooth® connection between the mobile phone and the cradle

The connection between the mobile phone and the cradle is automatically disconnected beyond the reception range of several meters.

### Manually disconnecting the Bluetooth® connection between the mobile phone and the cradle

The Bluetooth® connection can be manually disconnected as follows:

For the following vehicles: S-Class, model series W/V 221 and CL-Class, model series C 216:

- Select *Tel* → *Tel* → *Telephone off* using the COMAND controller. (Please refer to the vehicle Owner's Manual.)

On the mobile phone:

- Select *Menu* → *Settings* → *Connectivity* → *Bluetooth* → *Active devices* → *Disconn.* on the mobile phone. (Please refer to the mobile phone operating instructions.)

#### Notes

During an active call, the connection between the mobile phone and the cradle can only be disconnected on the mobile phone. (Please refer to the mobile phone operating instructions.)

After the Bluetooth® connection has been manually disconnected, an active call can be connected to the vehicle by pressing the Bluetooth® button on the cradle.

### General notes on operation

On the mobile phone, the *Flight request* function must not be activated, otherwise the connection between the cradle and the inserted mobile phone will not be established. (Please refer to the mobile phone operating instructions.)

When the mobile phone is inserted in the cradle, the ringing tone always sounds, even if the *Silent* profile is enabled.

You should not store too many text messages (SMS) in the Inbox of the mobile phone. (Please refer to the mobile phone operating instructions.)

For information on operating the mobile phone via the multi-function steering wheel, please refer to the COMAND and/or audio system operating instructions and/or the vehicle Owner's Manual.

Press the **+** or **-** button to adjust the volume during a telephone call.

The settings for the transmission of the telephone number in hands-free mode must be made by the network provider or the service provider. To make these settings, please contact the network provider or the service provider.

If a call is made directly from the mobile phone while there is an active connection between the cradle and the mobile phone, the telephone number will not be transmitted or displayed.

It is recommended that you switch off the mobile phone at least once a month. (Please refer to the mobile phone operating instructions.)

### Speed-dial keys

#### Speed-dial key for mailbox

The **5** key can be programmed as a speed-dial key for your mailbox.

Add the following entry to the phonebook. (Please refer to the mobile phone operating instructions.)

Name: Mailbox  
number: Number of mailbox.

#### Other speed-dial keys

It is possible to access the speed-dial keys 2 to 9 via the buttons **2** to **9** on COMAND or the audio system.

#### Note

You must save speed-dial numbers on memory keys 2 to 9 on the mobile phone according to your preference.

#### Calling up the speed-dial keys

Press and hold the corresponding button on COMAND or the Audio system for approx. 3 seconds.

### Transferring the phonebook

In order to use the mobile phone phonebook on the COMAND or the audio system, it must be transferred via the cradle. The phone book is transferred automatically after the Bluetooth® connection has been established. The download can take up to 10 minutes, depending on the size of the phone book, and will be indicated by a symbol on the display of the mobile phone.

#### Note

The phone book transfer is vehicle-specific. On vehicles with a date of manufacture before 08/2008<sup>1</sup> it is possible that two numbers can be transferred for each phone book entry. The transferred numbers will be saved in two individual phone book entries in COMAND or the audio system and will be assigned to the corresponding category (for example "M" for "mobile").

### Removing the mobile phone

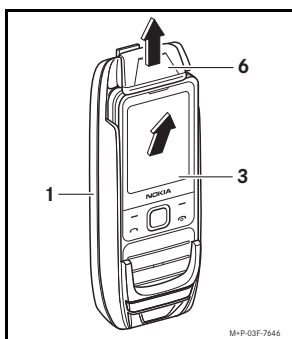

Slide the locking tab (6) upwards and remove the mobile phone (3) from the cradle (1).

### Detaching the cradle

1. Remove the mobile phone from the cradle (see above).

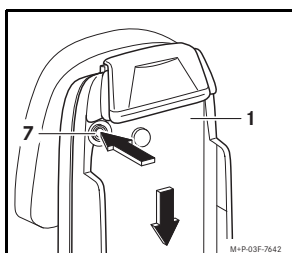

2. Press the release button (7), slide the cradle (1) downwards and remove.

1. Information on this is available at any Mercedes-Benz Service Centre.